

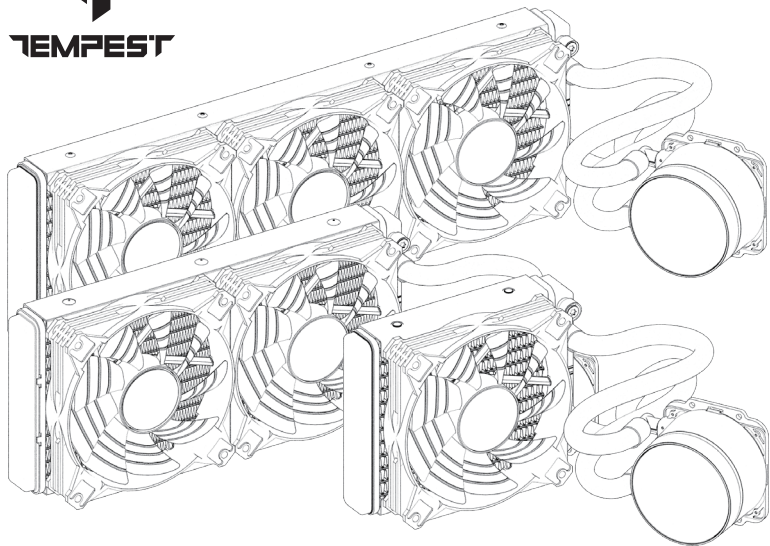

For model

TP-LCO-120ARGB | TP-LCO-120WARGB

TP-LCO-240WARGB | TP-LCO-360WARGB



ARGB LIQUID COOLER KIT

USER MANUAL • MANUAL DE USUARIO • MANUEL DE L'UTILISATEUR
BENUTZERHANDBUCH • MANUALE D'USO • MANUAL DO USUÁRIO

PART LIST

A

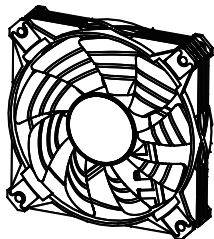

Radiator Fan

120x1 240x2 360x3

B

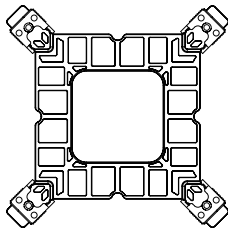

Intel Backplate

C

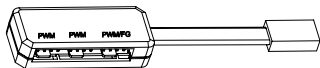

PWM Connector

240x1 360x1

D

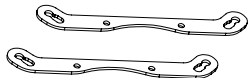

Intel Clip

E

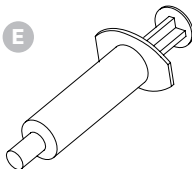

Thermal Grease

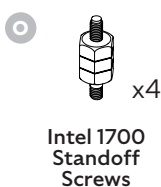
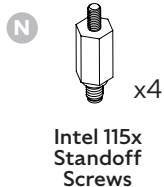
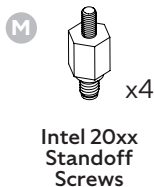
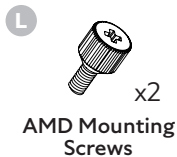
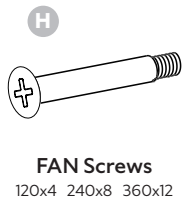
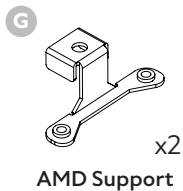
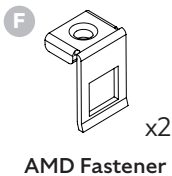

LISTA DE PIEZAS

A

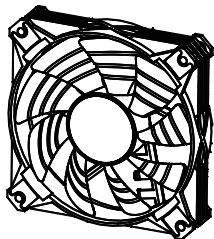

Ventilador del radiador

120x1 240x2 360x3

B

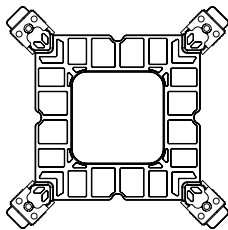

Placa posterior Intel

C

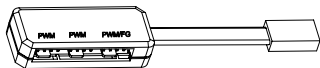

Conector PWM

240x1 360x1

D

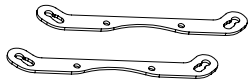

Clip Intel

E

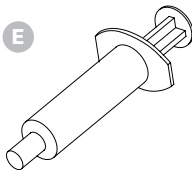

Grasa térmica

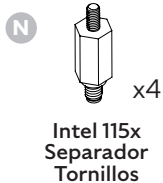
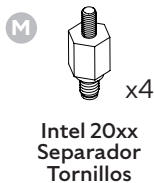
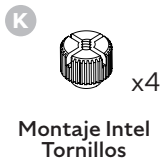
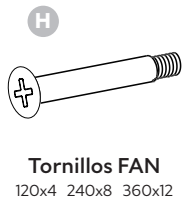
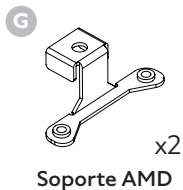
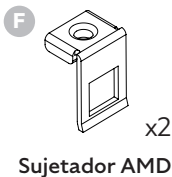

LISTE DES PARTIES

A

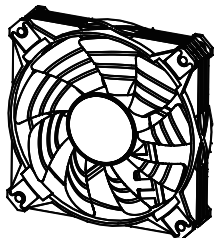

Ventilateur de radiateur
120x1 240x2 360x3

B

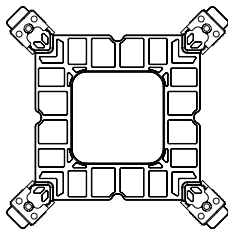

Plaque arrière Intel

C

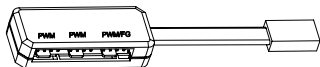

Connecteur PWM
240x1 360x1

D

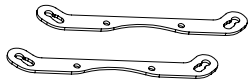

Intel Clip

E

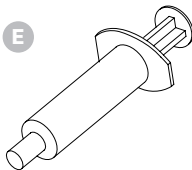

Graisse thermique

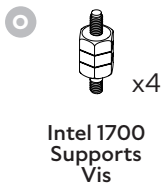
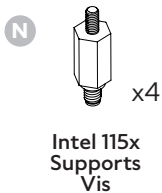
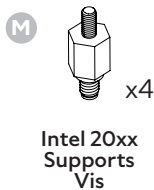
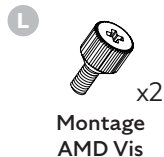
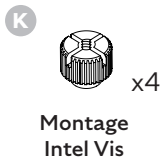
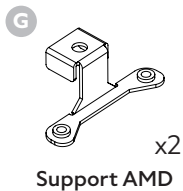
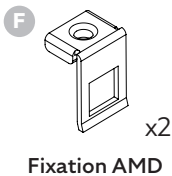

Bitte prüfen Sie genau, ob die im Paket
enthaltenen Teile übereinstimmen

A

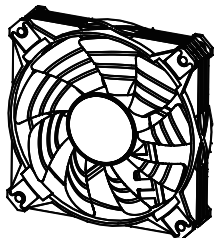

Kühlerlüfter

120x1 240x2 360x3

B

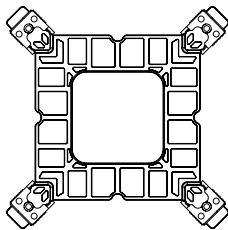

Intel Backplate

C

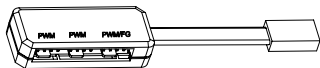

PWM-Anschluss

240x1 360x1

D

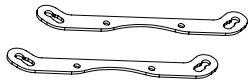

Intel-Clip

E

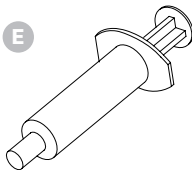

Thermisches Schmierfett

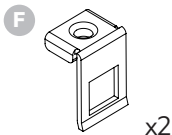

AMD-Befestigung

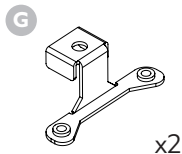

AMD-Unterstützung

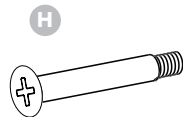

FAN-Schrauben
120x4 240x8 360x12



Heizkörper-Schrauben

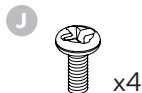

Befestigungsschrauben



Intel-Montage Schrauben

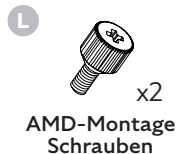

AMD-Montage Schrauben

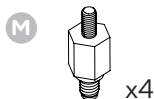

Intel 20xx
Abstandshalter
Schrauben

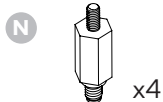

Intel 115x
Abstandshalter
Schrauben

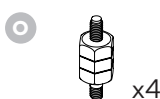

Intel 1700
Abstandshalter
Schrauben

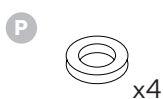

Gummi
Unterlegscheibe

ELENCO PARTI

Si prega di verificare in dettaglio se le parti incluse nella confezione corrispondono

A

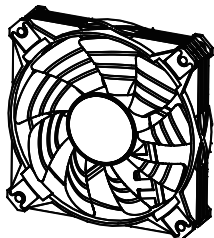

Ventola del radiatore
120x1 240x2 360x3

B

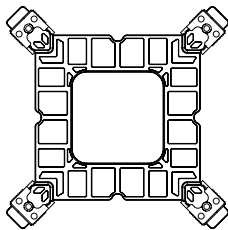

Piastra posteriore Intel

C

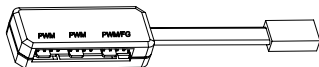

Connettore PWM
240x1 360x1

D

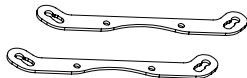

Clip Intel

E

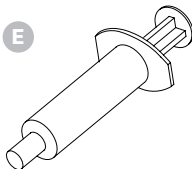

Grasso termico

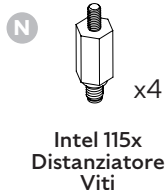
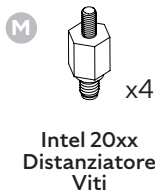
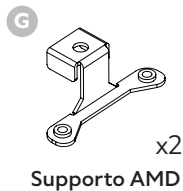
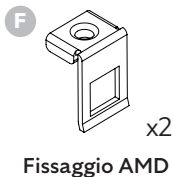

LISTA DE PEÇAS

Verificar em pormenor se as peças incluídas na embalagem correspondem

A

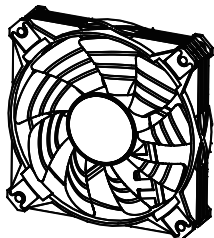

Ventilador do radiador
120x1 240x2 360x3

B

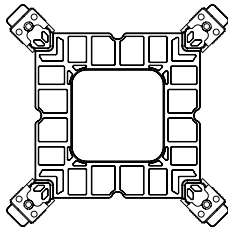

Placa posterior Intel

C

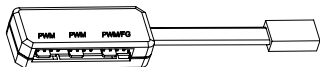

Conector PWM
240x1 360x1

D



Clipe Intel

E

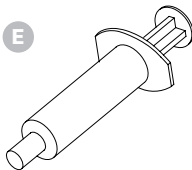

Massa térmica

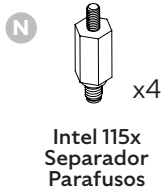
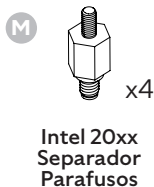
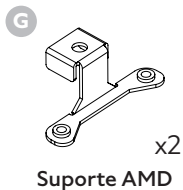
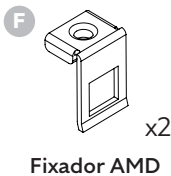

1

FOR PLATFORM

INTEL AMD

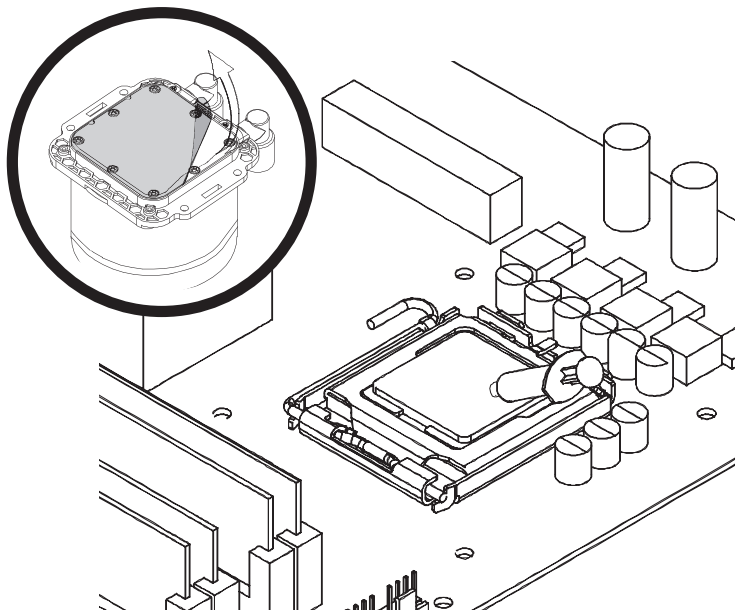

2

FOR PLATFORM

INTEL 20XX

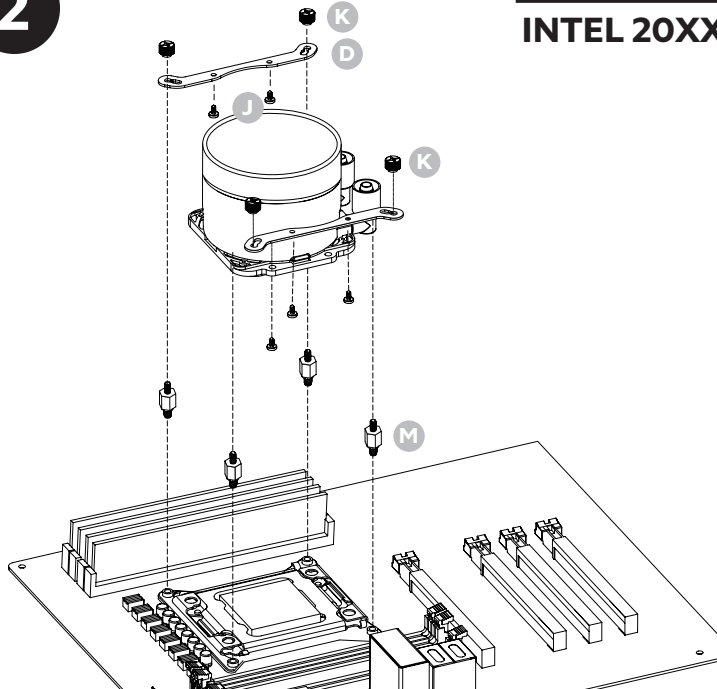

2

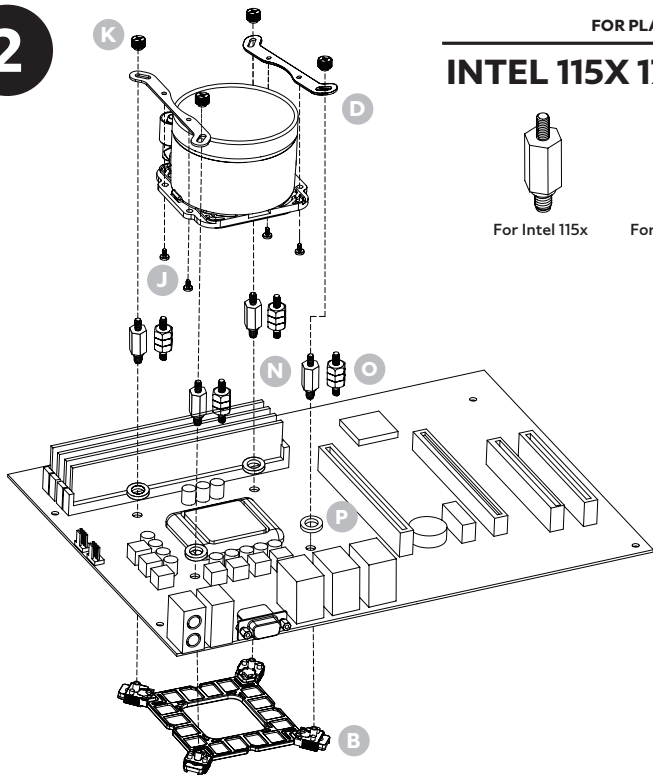

FOR PLATFORM

INTEL 115X 1700

2

FOR PLATFORM

AMD

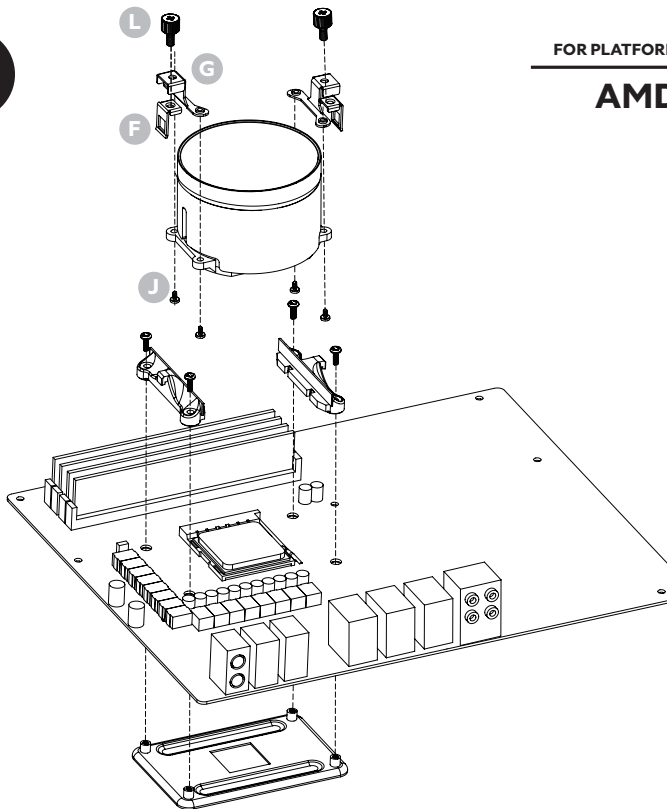

3

FOR PLATFORM

INTEL AMD

120 MODEL

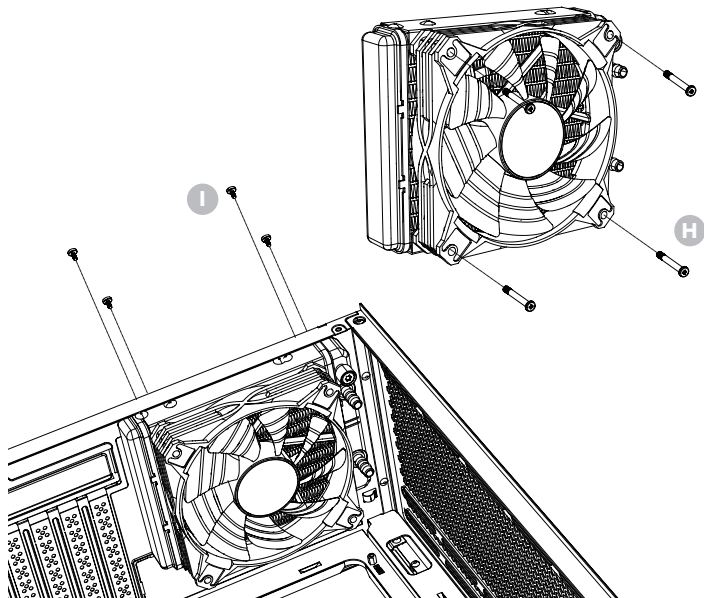

3

FOR PLATFORM

INTEL AMD

240 MODEL

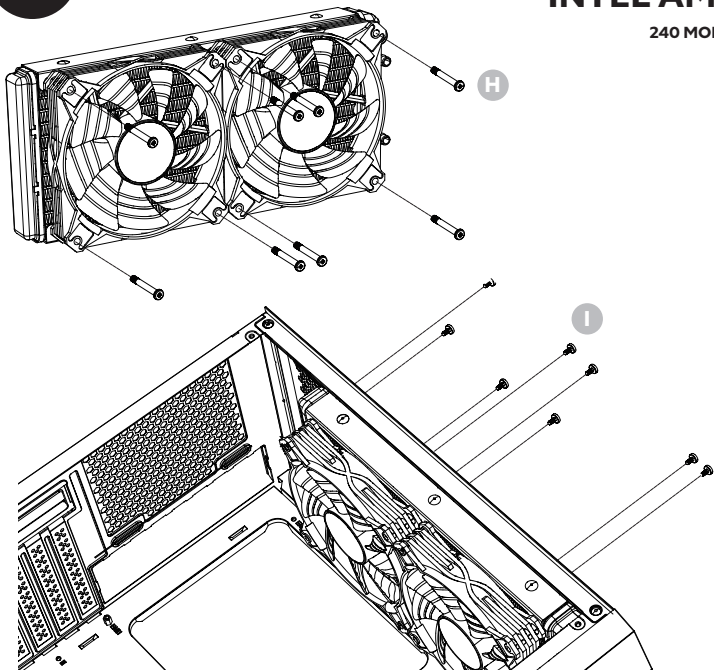

3

FOR PLATFORM

INTEL AMD

360 MODEL

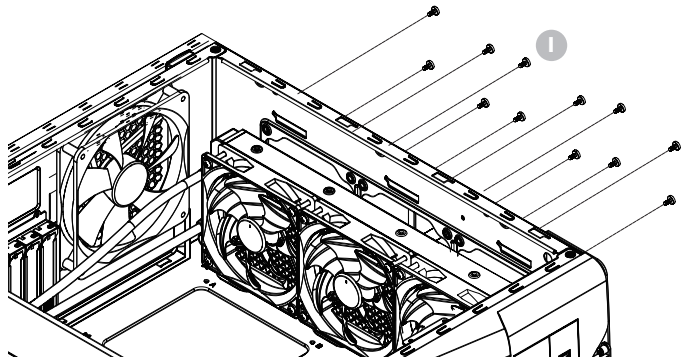
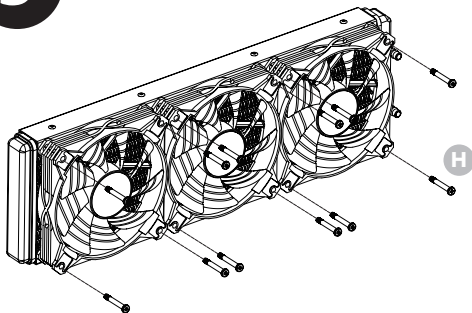

4

FOR PLATFORM

INTEL AMD

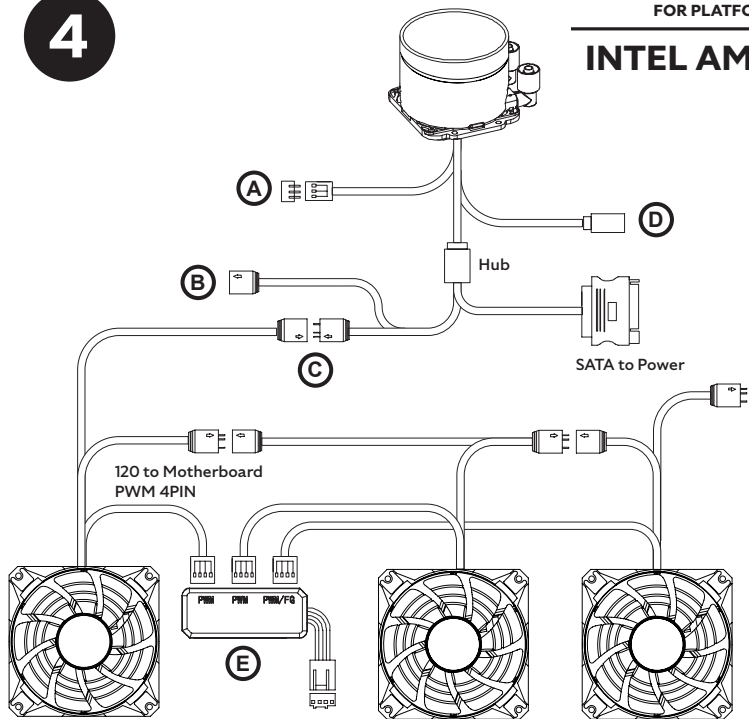

For 240 or 360 model

EN Wiring instructions

- (A) Motherboard fan 3pin
- (B) Connect to the 5V/3pin ARGB socket
- (C) Connect to rest cable to change the reset button as LED control button
- (D) Connect the 3-pin pump connector to the fan 3pin socket
- (E) Connect to motherboard PWM fan 4pin

ES Instrucciones de cableado

- (A) Ventilador de placa base 3pin
- (B) Conectar a la toma ARGB 5V/3pin
- (C) Conectar al cable de descanso para cambiar el botón de reinicio como botón de control LED
- (D) Conecte el conector de 3 pines de la bomba a la toma de 3 pines del ventilador
- (E) Conectar al ventilador PWM de la placa base 4pin

FR Instructions de câblage

- (A) Ventilateur de carte mère 3 broches
- (B) Connexion à la prise ARGB 5V/3 broches
- (C) Connecter le câble de repos pour transformer le bouton de réinitialisation en bouton de contrôle de la LED
- (D) Brancher le connecteur à 3 broches de la pompe sur la prise à 3 broches du ventilateur
- (E) Connexion au ventilateur PWM 4 broches de la carte mère

DE Anweisungen zur Verdrahtung

- (A) Motherboard-Lüfter 3pin
- (B) Anschluss an die 5V/3pin ARGB-Buchse
- (C) Verbinden Sie den Reset-Taster mit dem Restkabel, um ihn als LED-Kontrolltaste zu verwenden
- (D) Verbinden Sie den 3-poligen Pumpenstecker mit der 3-poligen Lüfterbuchse
- (E) Anschluss an Motherboard PWM-Lüfter 4pin

IT Istruzioni per il cablaggio

- (A) Ventola della scheda madre a 3 pin
- (B) Collegare alla presa ARGB da 5 V/3 pin
- (C) Collegare al cavo di riposo per trasformare il pulsante di reset in un pulsante di controllo del LED
- (D) Collegare il connettore a 3 pin della pompa alla presa a 3 pin della ventola
- (E) Collegare alla ventola PWM a 4 pin della scheda madre

PT Instruções de cablagem

- (A) Ventoinha da placa-mãe de 3 pinos
- (B) Ligar à tomada ARGB de 5V/3 pinos
- (C) Ligar ao cabo de repouso para alterar o botão de reposição como botão de controlo LED
- (D) Ligar o conetor de 3 pinos da bomba à tomada de 3 pinos da ventoinha
- (E) Ligação à ventoinha PWM de 4 pinos da placa-mãe



ARGB LIQUID COOLER KIT

more information at: www.tempestofficial.com

