

T TEMPEST
G A M I N G

SPIRIT

RGB ATX GAMING CASE

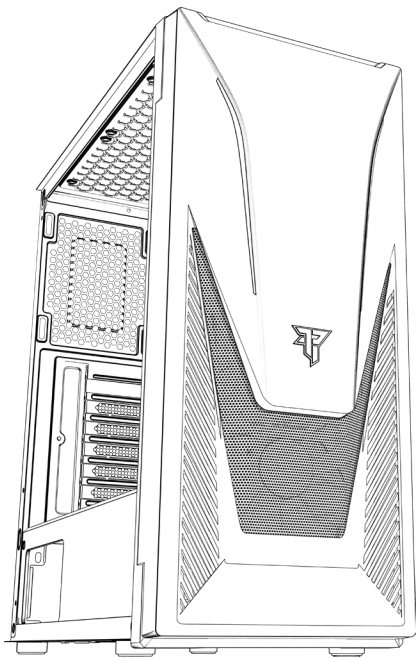

TEMPEST
G A M I N G

SPIRIT

RGB ATX GAMING CASE

ACCESSORY BAG

1

Hard Drive's bay
screw (10mm)**x4**

2

Motherboard
standoffs (6,5mm)**x2**

3

Motherboard/SSD
Screw (5mm)**x12**

4



PSU/PCIE Screw (6mm)

x6

5



3,5" HDD Screw (5mm)

x4

6



Fan Screws (28mm)

x4

7



PCI Card

x1

7

Zip ties for
cable management**x5**

STEP A: Disassemble the side panel and the front panel

Take out the screws before disassembling side panel.

Remove the side panels before disassembling the front panel

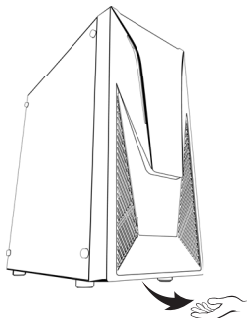
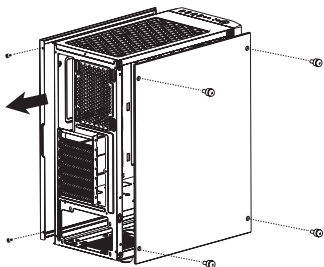

Special attention to the tempered glass side panel.
Handle with care.

STEP B: Install the power supply

Make sure the screw holes for PSU and the PC case are aligned before screwing.

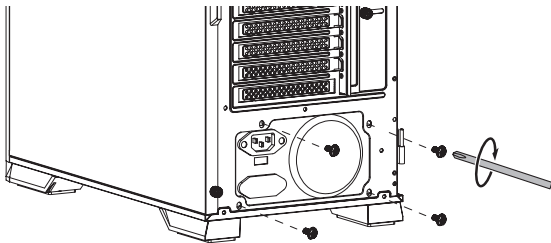

STEP C: Install the motherboard

Make sure that the motherboard aims at the copper cylinder and install the standoffs (No.2) before screwing in with the No.3 screws.

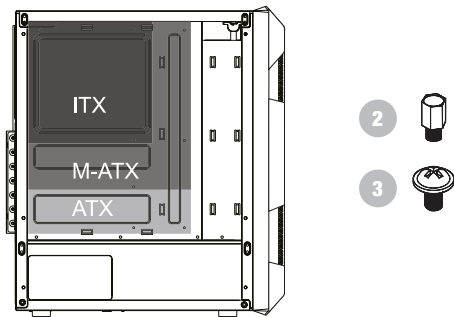

STEP D: Install fan and radiator

Front Fans

- x3 120mm

Radiator up to 240mm

Rear Fan

- x1 120mm

Radiator up to 120mm

Top Fans

- x2 120mm

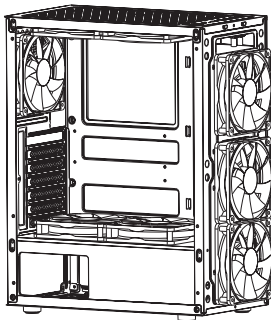

STEP E: Install HDD and SSD

Use Hard Disk Bay enclosure for both SSD and HDD, unscrew the enclosure from the case and install the disk with no.1/3/5 screws

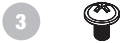

2.5" SSDx1
3.5" HDDx2

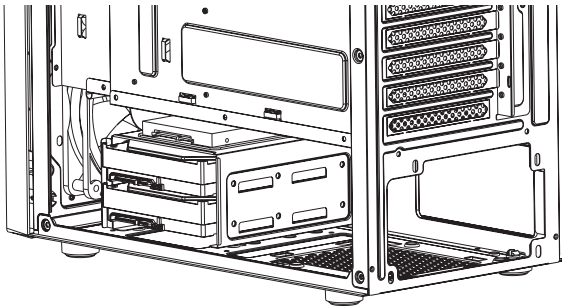
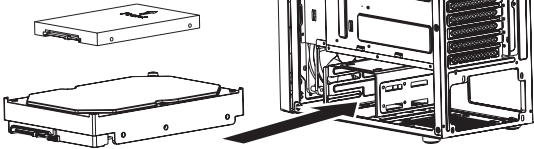

STEP F: INSTALL THE GRAPHICS CARD

Remove the baffle marked in the picture, make sure the VGA card aims at the motherboard slot and then fix VGA card and case with No.4 screw.

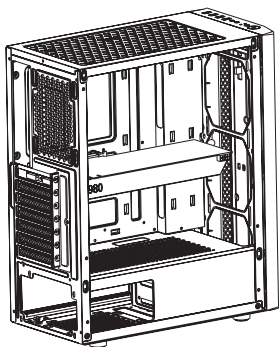

FRONT PANEL I/O AND MOTHERBOARD CONNECTORS

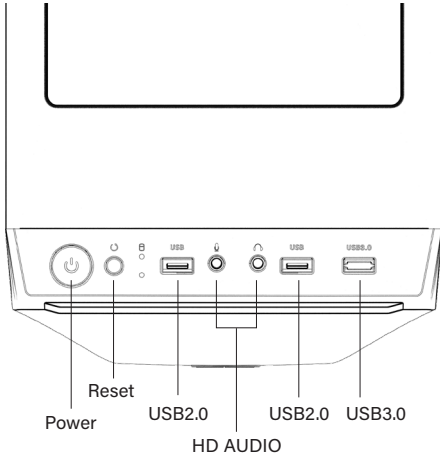

case AzaliaHD Audio connector

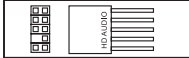

case USB connector

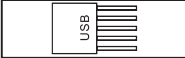

case USB3.0 connector (Optional)

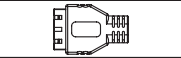

Motherboard HD Audio connector

PORT1L	AUD GND
PORT1R	PRESENSE#
PORT2R	SENSE1 RETURN
SENSE SEND	NO PIN
PORT2L	SENSE RETURN

Motherboard USB connector

VCC	VCC
D-	D-
D+	D+
GND	GND
	NC

Motherboard USB3.0 connector



H.D.D LED



-P LED

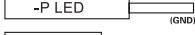

+P LED



POWER SW



ACCESORIOS PARA INSTALACION

1

Tornillo para bahía
de disco duro**x4**

2



Soporte para placa base

x2

3

Tornillo para placa
base / SSD**x12**

4

Tornillo para fuente de
alimentación y PCIE**x6**

5

Tornillo para discos
duros de 3,5"**x4**

6



Tornillo para ventiladores

x4

7



Pletina repuesto PCI

x1

7

Brida para gestión
de cableado**x5**

STEP A:**Desmontar los paneles laterales y el panel frontal.**

Quitar los tornillos de ambos paneles laterales antes de desmontar los paneles laterales.

Quitar previamente los paneles laterales antes de poder desmontar el Panel frontal.

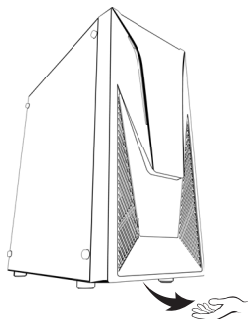
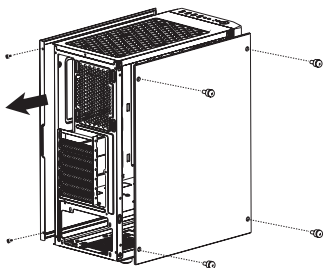

Precaución al desmontar el panel de cristal templado.
Manejar con cuidado.

STEP B: Instalación de la fuente de alimentación.

Asegúrate que los huecos para los tornillos de la fuente de alimentación se alinean de manera correcta con los de la torre antes de atornillar.

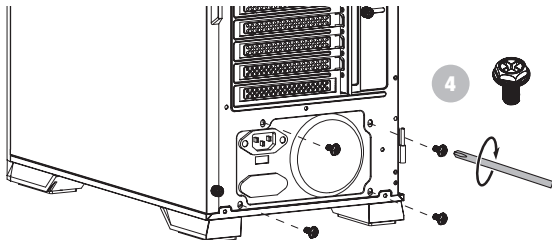

STEP C: Instalación de la placa base.

Asegúrate que la placa base se alinea con los huecos marcados en la torre e instala los alzadores de cobre (No.2) antes de atornillar la placa base a la torre con los tornillos No.3

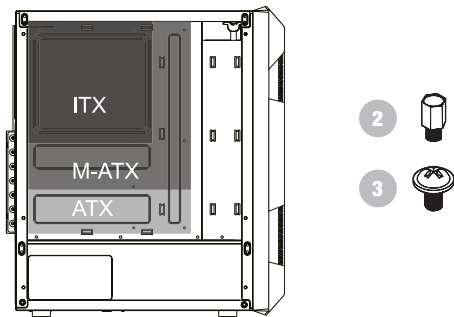

STEP D: Instalación de ventiladores y/o radiadores

Frontal

- x3 120mm

Radiador hasta 240mm

Superior

- x1 120mm

Radiador hasta 120mm

Trasero

- x2 120mm

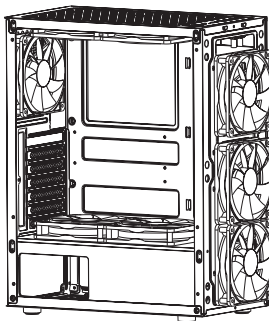

STEP E: Install HDD and SSD

Usa la bahía de discos duros para HDD y SSD, desatornilla la bahía de la torre e instala los discos dentro con el tornillo no.1/3/5

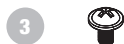

2.5" SSDx1
3.5" HDDx2

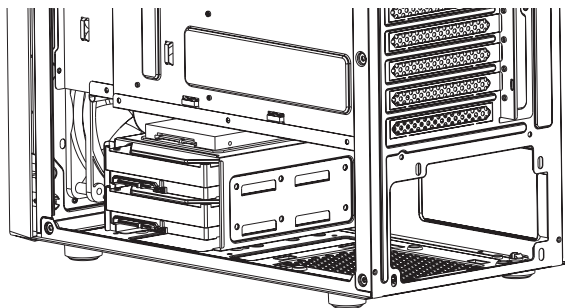
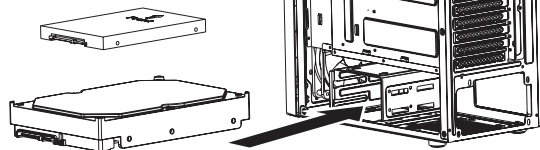

STEP G: Instalación de tarjeta gráfica y desmontar el slot de expansión PCI.

Retira el embellecedor que necesites alineando con la ranura PCI de la placa base, luego instala la tarjeta gráfica y asegúrala a la torre con el tornillo No.4

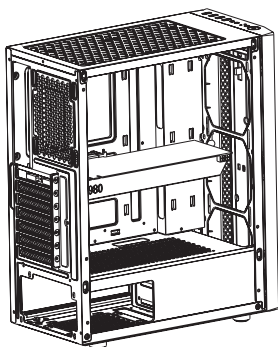

PANEL FRONTAL DE E/S Y CONECTORES PARA PLACA BASE

ES

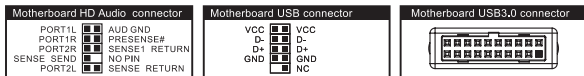
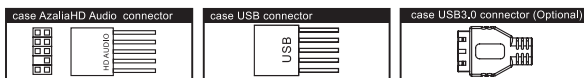
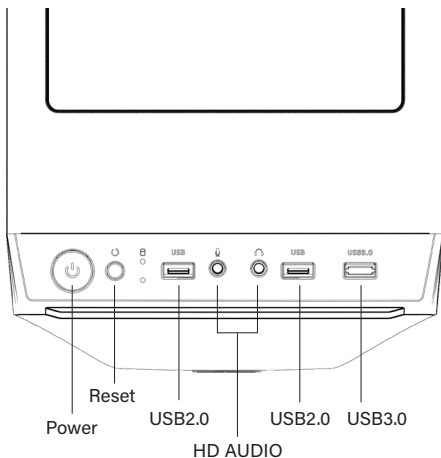



MORE INFORMATION AT www.tempestofficial.com

