

**TEMPEST**  
G A M I N G

**SHADE**

RGB ATX GAMING CASE

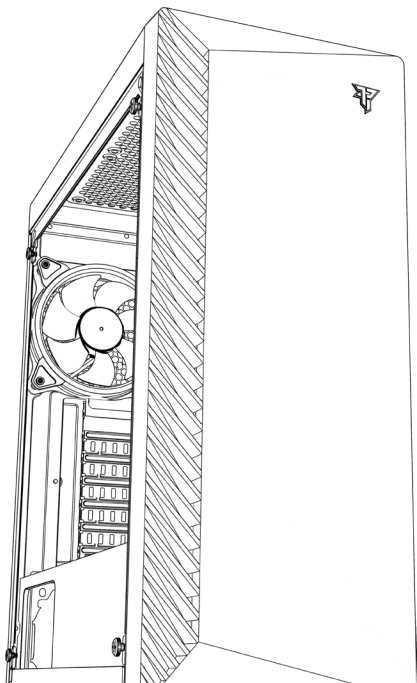



**TEMPEST**  
G A M I N G

**SHADE**

RGB ATX GAMING CASE

## ACCESSORY BAG

1

Zip ties for  
cable management**x5**

2

Motherboard  
standoffs (6,5mm)**x3**

3

Motherboard/SSD  
Screw (5mm)**x13**

4



PSU/PCIE Screw (6mm)

**x6**

5



3,5" HDD Screw (5mm)

**x5**

6

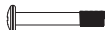

Fan Screws (28mm)

**x4**

7



PCI Card

**x1**

## STEP A: Disassemble the side panel and the front panel

Take out the screws before disassembling side panel.  
Remove the side panels before disassembling the front panel

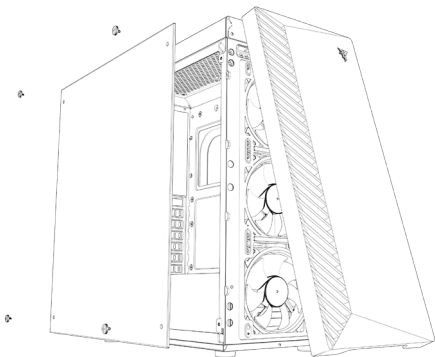

Special attention to the tempered glass side panel.  
Handle with care.

## STEP B: Install the power supply

Make sure the screw holes for PSU and the PC case are aligned  
before screwing.

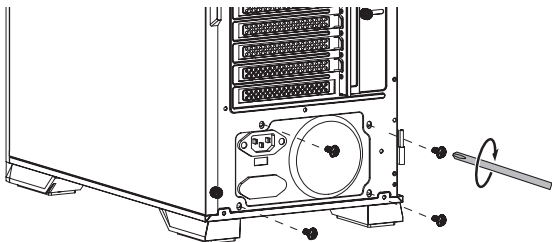

4



## STEP C: Install the motherboard

Make sure that the motherboard aims at the copper cylinder and install the standoffs (No.2) before screwing in with the No.3 screws.

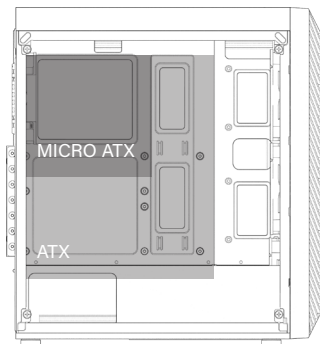

## STEP D: Install fan and radiator

Front Fans  
- x3 120mm

Rear Fan  
- x1 120mm

Top Fans  
- x2 120mm

PSU Cover  
- x2 120mm

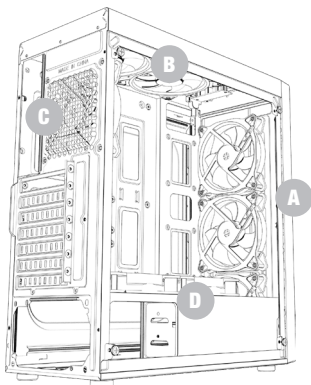

## STEP E: Install HDD/SSD

Use Hard Disk Bay enclosure for both SSD and HDD, unscrew the enclosure from the case and install the disk with no.3 screws

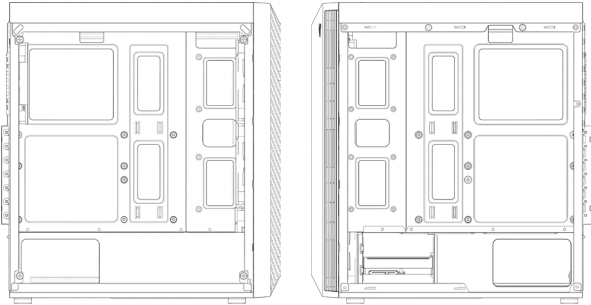

3

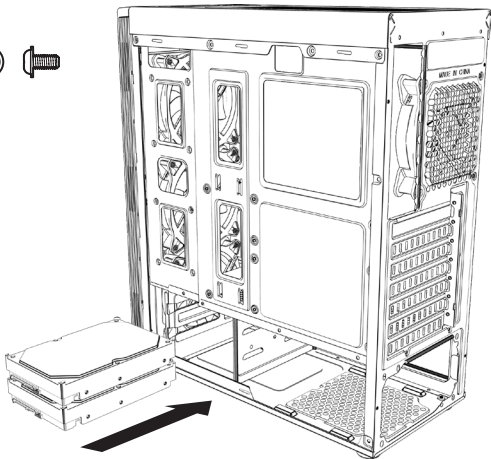

## STEP G: Install Graphic card

Remove the baffle marked in the picture, make sure the VGA card aims at the motherboard slot and then fix VGA card and case with No.4 screw.

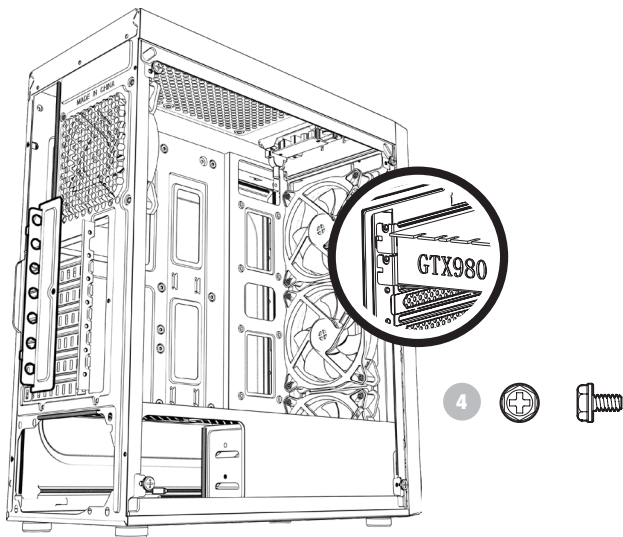



## FRONT PANEL I/O AND MOTHERBOARD CONNECTORS

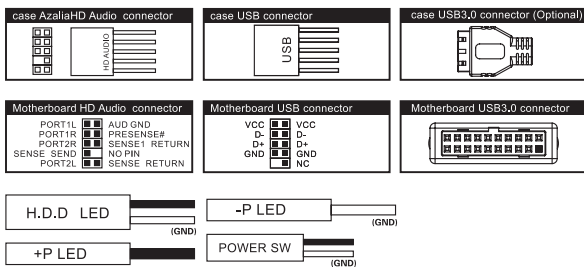
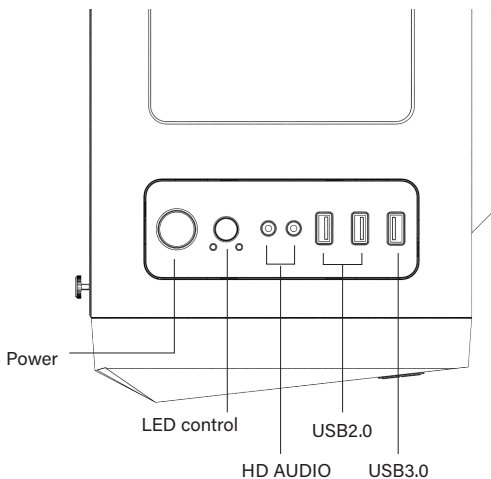

## ACCESORIOS PARA INSTALACION

1

Brida para gestión  
de cableado**x5**

2



Soporte para placa base

**x3**

3

Tornillo para placa  
base / SSD**x13**

4

Tornillo para fuente  
de alimentación y PCIE**x6**

5

Tornillo para discos  
duros de 3,5"**x5**

6



Tornillo para ventiladores

**x4**

7



Pletina PCI

**x1**

**STEP A:****Desmontar los paneles laterales y el panel frontal.**

Quitar los tornillos de ambos paneles laterales antes de desmontar los paneles laterales.

Quitar previamente los paneles laterales antes de poder desmontar el Panel frontal.

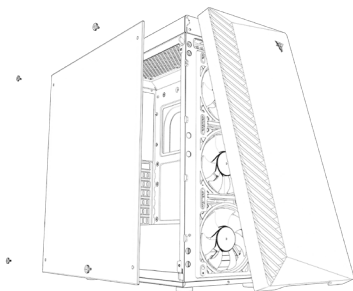

Precaución al desmontar el panel de cristal templado.  
Manejar con cuidado.

**STEP B: Instalación de la fuente de alimentación.**

Asegúrate que los huecos para los tornillos de la fuente de alimentación se alinean de manera correcta con los de la torre antes de atornillar.

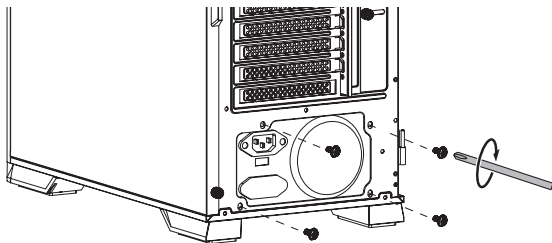

4



## STEP C: Instalación de la placa base.

Asegúrate que la placa base se alinea con los huecos marcados en la torre e instala los alzadores de cobre (No.2) antes de atornillar la placa base a la torre con los tornillos No.3

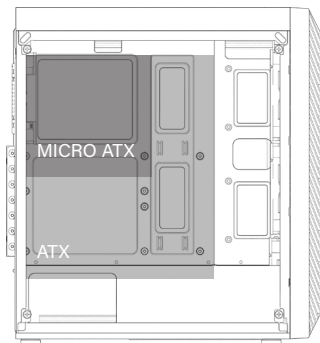

## STEP D: Instalación de ventiladores y/o radiadores

Frontal  
- x3 120mm

Superior  
- x1 120mm

Trasero  
- x2 120mm

Base de la fuente  
- x2 120mm

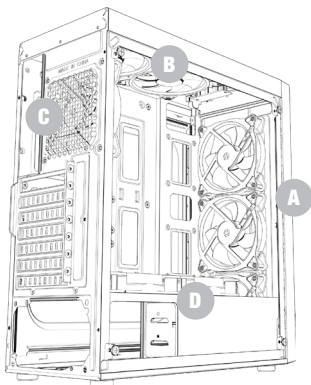

## STEP E: Instalación de discos duros HDD

Usa la bahía de discos duros para HDD y SSD, desatornilla la bahía de la torre e instala los discos dentro con el tornillo no.3

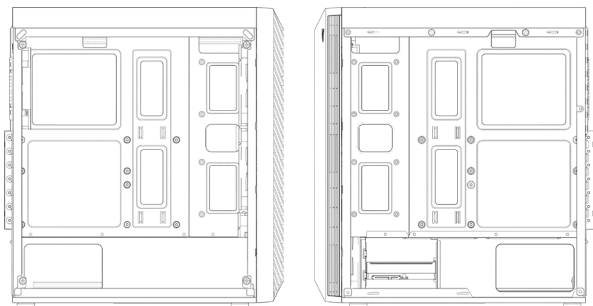

3

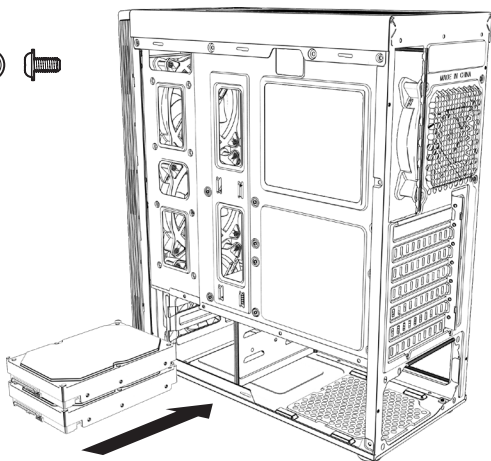

## STEP G: Instalación de tarjeta gráfica y desmontar el slot de expansión PCI.

Retira el embellecedor que necesites alineando con la ranura PCI de la placa base, luego instala la tarjeta gráfica y asegúrala a la torre con el tornillo No.4

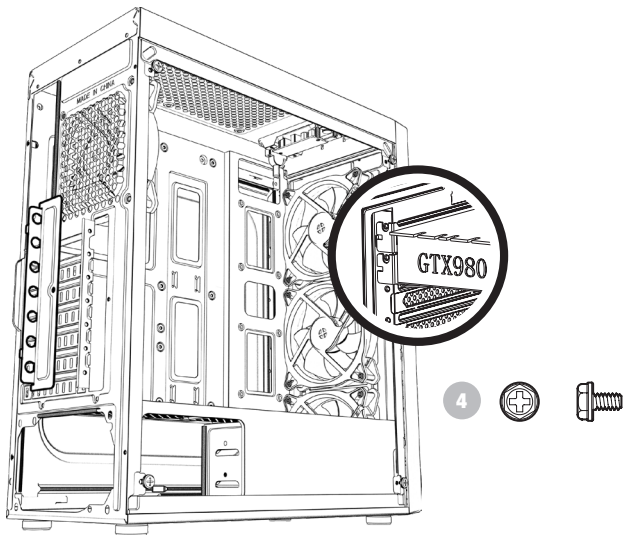

# PANEL FRONTAL DE E/S Y CONECTORES PARA PLACA BASE

ES

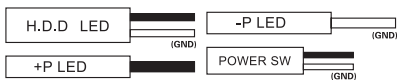
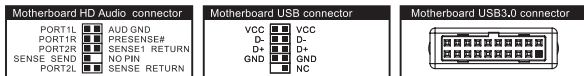
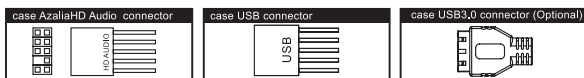
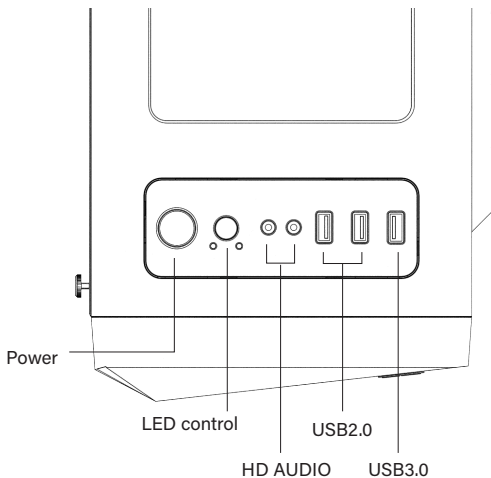



**MORE INFORMATION AT** [www.tempestofficial.com](http://www.tempestofficial.com)

